



BRIGHTLOTS

PARKING LOT LIGHTING & MAINTENANCE PRODUCTS

SHOP

- Poles
- Pole Accessories
- LED Fixtures
- LED Retrofits
- LED Pole Kits
- Emergency Exit Lights
- Parking Lot Safety Products

TABLE OF CONTENTS

LED Pole Kits	2
Decorative Pole Kits	10
4 LED Aluminum Pole Kits	11
3 LED Aluminum Pole Kits	13
2 LED Aluminum Pole Kits	16
1 LED Aluminum Pole Kit	18

LED POLE KITS



WYSE-SERIES DECORATIVE LED POLE KIT | 60W, 100W | 12FT., 14FT., 16FT. | ANCHOR BASE

Build your own decorative LED-Pole Kit
 Pole Selection: Heights available; 12ft., 14ft., 16ft. Round tapered aluminum pole.
 LED Fixture Selection: WYSE Series LEDs. 60W - 100W options. 120-277V
 Finish: Black powder coat only.
 FREE Shipping.
 Detailed spec sheets are below under DOWNLOAD section

[Read More](#)

SKU: N/A

Price: \$1,186.60 — \$1,437.40 \$1,127.27 - \$1,365.53

Categories: [Decorative Pole Kits](#), [LED Pole Kits](#)

BUILD YOUR LED-POLE KIT | 100W-300W LEDS | 10 FT. - 25 FT. SQUARE ALUMINUM POLE | 4 LED



Build your own LED-Pole Kit

Pole Selections: Square Aluminum Pole. Heights: 10ft., 15ft., 20ft., 25ft.
 LED Fixture Selections: FERIS Pole Top Fixtures. Wattages: 100W, 150W, 200W, 240W, 300W
 Voltage: 120-277V, 347-480V
 Finish Selections: Dark Bronze (standard), Black, White
 FREE Shipping
 Detailed Spec sheets are below under the DOWNLOAD tab

[Read More](#)

SKU: N/A

Price: From: \$1,387.32 \$1,317.95

Categories: [4 LED Aluminum Pole Kits](#), [LED Pole Kits](#)

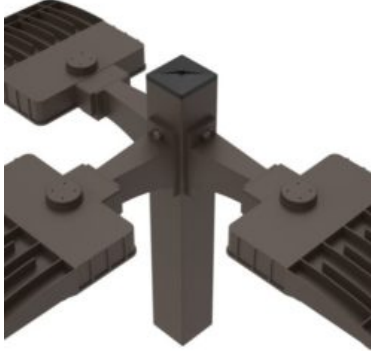

BUILD YOUR LED-POLE KIT | 100W-300W LEDS | 10 FT. - 25 FT. SQUARE ALUMINUM POLE | 3 LED

Build your own LED-Pole Kit

Pole Selections: Square Aluminum Pole. Heights: 10ft., 15ft., 20ft., 25ft.
LED Fixture Selections: FERIS Pole Top Fixtures. Wattages: 100W, 150W, 200W, 240W, 300W
Voltage: 120-277V, 347-480V
Finish Selections: Dark Bronze (standard), Black, White
FREE Shipping
Detailed Spec sheets are below under the DOWNLOAD tab

[Read More](#)

SKU: N/A

Price: From: ~~\$1,232.22~~ ~~\$1,170.61~~

Categories: [3 LED Aluminum Pole Kits](#), [LED Pole Kits](#)

BUILD YOUR LED-POLE KIT | 100W-300W LEDS | 10 FT. - 25 FT. SQUARE ALUMINUM POLE | 2 LED

Build your own LED-Pole Kit

Pole Selections: Square Aluminum Pole. Heights: 10ft., 15ft., 20ft., 25ft.
LED Fixture Selections: FERIS Pole Top Fixtures. Wattages: 100W, 150W, 200W, 240W, 300W
Voltage: 120-277V, 347-480V
Finish Selections: Dark Bronze (standard), Black, White
FREE Shipping
Detailed Spec sheets are below under the DOWNLOAD tab

[Read More](#)

SKU: N/A

Price: From: ~~\$1,077.12~~ ~~\$1,023.26~~

Categories: [2 LED Aluminum Pole Kits](#), [LED Pole Kits](#)



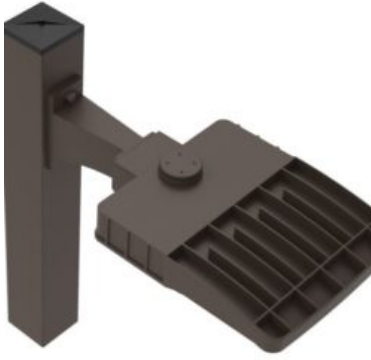

BUILD YOUR LED-POLE KIT | 100W-300W LEDS | 10 FT. - 25 FT. SQUARE ALUMINUM POLE | 1 LED

Build your own LED-Pole Kit

Pole Selections: Square Aluminum Pole. Heights: 10ft., 15ft., 20ft., 25ft.
LED Fixture Selections: FERIS Pole Top Fixtures. Wattages: 100W, 150W, 200W, 240W, 300W

Voltage: 120-277V, 347-480V

Finish Selections: Dark Bronze (standard), Black, White

FREE Shipping

Detailed Spec sheets are below under the DOWNLOAD tab

[Read More](#)

SKU: N/A

Price: From: ~~\$922.02~~ \$875.92

Categories: [1 LED Aluminum Pole Kit](#), [LED Pole Kits](#)

BUILD YOUR LED-POLE KIT | 100W-150W-200W LEDS | 20 FT. - 35 FT. ALUMINUM TAPERED POLE | 3 LEDS



Our LED - Pole Kits include 3 LED fixtures (100, 150, 200 Watts available) and one LED-Ready tapered aluminum poles (20, 25, 30, and 35 feet available). The kit also includes 3 head tenon top aluminum brackets at 180 degrees. The only available color for kit building is dark bronze. We can make these kits in black, gray, or white however these will be custom made and pricing and lead-time will be impacted. If you have any questions please give us a call at (888)364-8802 or send us an email at customerservice@brightlots.com

instructions. scroll further down to build your led pole kit

[Step 1 Select your LED Fixture Options](#)

FERIS LED Fixtures - 140 Lumens per Watt



- Select from 100, 150 or 200 Watt
- Select your mounting bracket. In this case only Slip Fitter option is available as the poles are equipped with tenons to accommodate slip fitters.
- Select your photo sensor option.
- Select your motion sensor option.
- The quantity in this case will be 1 per kit. It is already set to 1 fixture.

- Click on the "Review Your Selection" to move to pole options

[Step 2 Select your Pole Options](#)

20, 25, 30 or 35 ft. LED-Ready Aluminum Tapered Poles

These poles come equipped with triple tenon inline bracket that will accommodate three LED fixtures with slip fitters at 180 degrees



- Select the color option; dark bronze. Please note, dark bronze is the only color option for these kits if you are buying online. Other colors are available. Please give us a call at (888)364-8802 or send us an email at customerservice@brightlots.com
- Select the anchor bolt covers. There are two options; anchor covers or a complete pole base cover.
- Click on the "Review Your Selection" to do a final review of the kit you built.

[Final Review and Purchase](#)

Your Kit is Ready To Review

Take a look at the kit you built. It is a 3 fixture at 180 degrees pole kit. Please recheck your selections. Now you can order the quantity of kits you need for your project by inserting the quantity you need. Remember this is the kit quantity; if you order 2 kits it will mean you are ordering 6 LED fixtures and 2 poles.

If you have any questions or are not sure of your selection or require a kit that is not available with these options give us a call at (888)364-8802 or email us at customerservice@brightlots.com

We offer other LED Pole kits that have single double triple heads and variety of combinations. [Click Here](#) to see our full line of LED Pole Kits.

[Read More](#)

SKU: N/A

Price: From: ~~\$2,002.45~~ \$1,902.33

Categories: [3 LED Aluminum Pole Kits](#), [LED Pole Kits](#)

1. LED Fixtures | FERIS



FERIS Series - 120-277V - 100W
 FERIS 120V Mounting Options: Slip Fitter - SF
 FERIS 120V Photo Sensor: Yes (Adder \$18)
 FERIS 120V Motion Sensor: Yes (Adder \$37)
 \$167.00 **\$187.15**

EDIT

2. LED-Ready Aluminum Pole



LBRTAF-6201564B31* 20 ft, 6" Butt Dia. 0.150 ga. 3 Fixture 180, LED Ready Light Pole
 Color: Dark Bronze
 Anchor Bolt Cover Option: Complete Square Base Cover (Adder \$120)
 \$4,272.33 **\$1,208.66**

EDIT



BUILD YOUR LED-POLE KIT | 100W-150W-200W LEDS | 20 FT. - 25 FT. ALUMINUM TAPERED POLE | 2 LEDS

This LED - Pole Kit includes two LED fixtures of your choice (100, 150, 200 Watts available) and one of our 20 ft. or 25 ft. LED-Ready tapered aluminum poles. The kit also includes a two tenon top aluminum bracket. The only available color for the kit building is dark bronze. We can make these kits in black, gray, or white however these will be custom made and pricing and lead-time will be impacted. If you have any questions please give us a call at (888)364-8802 or send us an email at customerservice@brightlots.com

instructions. scroll further down to build your led pole kit

[Step 1 Select your LED Fixture Options](#)

FERIS LED Fixtures - 140 Lumens per Watt

- Select from 100, 150 or 200 Watt
- Select your mounting bracket. In this case only Slip Fitter option is available as the poles are equipped with tenons to accommodate slip fitters.
- Select your photo sensor option.
- Select your motion sensor option.
- The quantity in this case will be 1 per kit. It is already set to 1 fixture.
- Click on the "Review Your Selection" to move to pole options

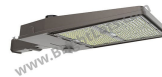

[Step 2 Select your Pole Options](#)

20 ft. or 25 ft. LED-Ready Aluminum Tapered Poles

These poles come equipped with double tenon inline bracket that will accommodate two LED fixtures with slip fitters at 180 degrees

- Select the color option; dark bronze. Please note, dark bronze is the only color option for these kits if you are buying online. Other colors are available. Please give us a call at (888)364-8802 or send us an email at customerservice@brightlots.com
- Select the anchor bolt covers. There are two options; anchor covers or a complete pole base cover.
- Click on the "Review Your Selection" to do a final review of the kit you built.



[Final Review and Purchase](#)

Your Kit is Ready To Review

Take a look at the kit you built. It is a 2 fixture at 180 degrees pole kit. Please recheck your selections. Now you can order the quantity of kits you need for your project by inserting the quantity you need. Remember this is the kit quantity; if you order 2 kits it will mean you are ordering 4 LED fixtures and 2 poles.

If you have any questions or are not sure of your selection or require a kit that is not available with these options give us a call at (888)364-8802 or email us at customerservice@brightlots.com

We offer other LED Pole kits that have single double triple heads and variety of combinations. Click Here to see our full line of LED Pole Kits.

[Read More](#)

SKU: N/A

Price: From: ~~\$2,132.83~~ \$2,026.19

Categories: [2 LED Aluminum Pole Kits](#), [LED Pole Kits](#)

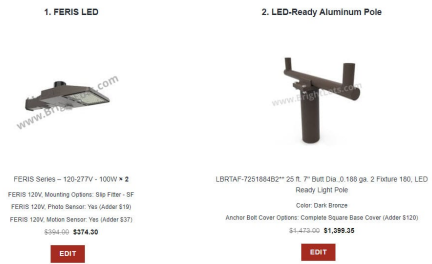

BUILD YOUR LED-POLE KIT | 200W-300W LEDS | 20 FT. - 35 FT. ALUMINUM TAPERED POLE | 4 LEDS

Our LED - Pole Kits include 4 LED fixtures (200 or 300 Watts available) and one LED-Ready tapered aluminum poles (20, 25, 30 and 35 feet available). The kit also includes 4 head tenon top aluminum bracket at 90 degrees. The only available color for kit building is dark bronze. We can make these kits in black, gray or white however these will be custom made and pricing and lead-time will be impacted. If you have any questions please give us a call at (888)364-8802 or send us an email at customerservice@brightlots.com



instructions. scroll further down to build your led pole kit

[Step 1 Select your LED Fixture Options](#)

FERIS LED Fixtures - 140 Lumens per Watt



- Select from 200 Watt or 300 Watt options
- Select your mounting bracket. In this case only Slip Fitter option is available as the poles are equipped with tenons to accommodate slip fitters.

- Select your photo sensor option.
- Select your motion sensor option.
- The quantity in this case will be 4 per kit. It is already set to 4 fixtures.
- Click on the "Review Your Selection" to move to pole options

[Step 2 Select your Pole Options](#)

20, 25, 30, 35 ft. LED-Ready Aluminum Tapered Poles





These poles come equipped with tenons that will accommodate 4 LED fixtures with slip fitters.

- Select from available pole heights: 20, 25, 30, 35 ft.
- Select the color option; dark bronze. Please note, dark bronze is the only color option for these kits if you are buying online. Other colors are available. Please give us a call at (888)364-8802 or send us an email at customerservice@brightlots.com
- Select the anchor bolt covers. There are two options; anchor covers or a complete pole base cover.
- Click on the "Review Your Selection" to do a final review of the kit you built.

[Final Review and Purchase](#)

Your Kit is Ready To Review

Take a look at the kit you built. It is a 4 fixture at 90 degrees pole kit. Please recheck your selections. Now you can order the quantity of kits you need for your project by inserting the quantity you need. Remember this is the kit quantity; if you order 2 kits it will mean you are ordering 8 LED fixtures and 2 poles.

<p>1. LED Fixtures FERIS</p>  <p>FERIS 120V Motion Sensor - Yes (J68M) \$37 \$940.00 \$380.00</p> <p>EDIT</p>	<p>2. LED-Ready Aluminum Pole</p>  <p>LBR2AF-0201984840** 20 ft. 8" Butt Dia. 3.188 ga. 4 Fixture 90, LED Ready Light Pole Color: Dark Bronze Anchor Bolt Cover Options: 4 Anchor Covers \$1,430.00 \$1,483.74</p> <p>EDIT</p>
---	--

\$2,479.62 **\$2,364.74**

[ADD TO CART](#)

If you have any questions or are not sure of your selection or require a kit that is not available with these options give us a call at (888)364-8802 or email us at customerservice@brightlots.com

We offer other LED Pole kits that have single double triple heads and variety of combinations. [Click Here](#) to see our full line of LED Pole Kits.

[Read More](#)

SKU: N/A

Price: From: ~~\$3,168.02~~ **\$3,009.62**

Categories: [4 LED Aluminum Pole Kits](#), [LED Pole Kits](#)

BUILD YOUR LED-POLE KIT | 100W-150W-200W LEDS | 20 FT. ALUMINUM TAPERED POLE | 1 LED



This LED - Pole Kit includes a single LED fixtures (100, 150, 200 Watts available) and one 20 ft. LED-Ready tapered aluminum poles. The kit also includes single tenon top aluminum bracket. The only available color for kit building is dark bronze. We can make these kits in black, gray or white however these will be custom made and pricing and lead-time will be impacted. If you have any questions please give us a call at (888)364-8802 or send us an email at customerservice@brightlots.com

instructions. scroll further down to build your led pole kit

[Step 1 Select your LED Fixture Options](#)

FERIS LED Fixtures - 140 Lumens per Watt

- Select from 75, 100 or 150 Watt
- Select your mounting bracket. In this case only Slip Fitter option is available as the poles are equipped with tenons to accommodate slip fitters.
- Select your photo sensor option.
- Select your motion sensor option.
- The quantity in this case will be 1 per kit. It is already set to 1 fixture.
- Click on the "Review Your Selection" to move to pole options

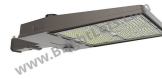

[Step 2 Select your Pole Options](#)

20, ft. LED-Ready Aluminum Tapered Poles

These poles come equipped with single tenon that will accommodate a single LED fixtures with slip fitters.

- Select the color option; dark bronze. Please note, dark bronze is the only color option for these kits if you are buying online. Other colors are available. Please give us a call at (888)364-8802 or send us an email at customerservice@brightlots.com
- Select the anchor bolt covers. There are two options; anchor covers or a complete pole base cover.
- Click on the "Review Your Selection" to do a final review of the kit you built.



[Final Review and Purchase](#)

Your Kit is Ready To Review

Take a look at the kit you built. It is a 4 fixture at 90 degrees pole kit. Please recheck your selections. Now you can order the quantity of kits you need for your project by inserting the quantity you need. Remember this is the kit quantity; if you order 2 kits it will mean you are ordering 8 LED fixtures and 2 poles.

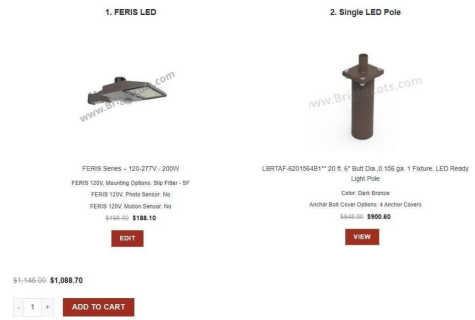

If you have any questions or are not sure of your selection or require a kit that is not available with these options give us a call at (888)364-8802 or email us at customerservice@brightlots.com

We offer other LED Pole kits that have single double triple heads and variety of combinations. Click Here to see our full line of LED Pole Kits.

[Read More](#)

SKU: N/A

Price: From: ~~\$1,570.20~~ **\$1,491.70**

Categories: [1 LED Aluminum Pole Kit](#), [LED Pole Kits](#)

DECORATIVE POLE KITS





**WYSE-SERIES DECORATIVE LED POLE KIT
| 60W, 100W | 12FT., 14FT., 16FT. |
ANCHOR BASE**

Build your own decorative LED-Pole Kit
 Pole Selection: Heights available; 12ft., 14ft., 16ft. Round tapered aluminum pole.
 LED Fixture Selection: WYSE Series LEDs. 60W - 100W options. 120-277V
 Finish: Black powder coat only.
 FREE Shipping.
 Detailed spec sheets are below under DOWNLOAD section

[Read More](#)

SKU: N/A

Price: ~~\$1,186.60~~ ~~— \$1,437.40~~ ~~\$1,127.27~~ - ~~\$1,365.53~~

Categories: [Decorative Pole Kits](#), [LED Pole Kits](#)

**4 LED ALUMINUM
POLE KITS**





BUILD YOUR LED-POLE KIT | 100W-300W LEDS | 10 FT. - 25 FT. SQUARE ALUMINUM POLE | 4 LED

Build your own LED-Pole Kit

Pole Selections: Square Aluminum Pole. Heights: 10ft., 15ft., 20ft., 25ft.
LED Fixture Selections: FERIS Pole Top Fixtures. Wattages: 100W, 150W, 200W, 240W, 300W

Voltage: 120-277V, 347-480V

Finish Selections: Dark Bronze (standard), Black, White

FREE Shipping

Detailed Spec sheets are below under the DOWNLOAD tab

[Read More](#)

SKU: N/A

Price: From: ~~\$1,387.32~~ \$1,317.95

Categories: [4 LED Aluminum Pole Kits](#), [LED Pole Kits](#)

BUILD YOUR LED-POLE KIT | 200W-300W LEDS | 20 FT. - 35 FT. ALUMINUM TAPERED POLE | 4 LEDS

Our LED - Pole Kits include 4 LED fixtures (200 or 300 Watts available) and one LED-Ready tapered aluminum poles (20, 25, 30 and 35 feet available). The kit also includes 4 head tenon top aluminum bracket at 90 degrees. The only available color for kit building is dark bronze. We can make these kits in black, gray or white however these will be custom made and pricing and lead-time will be impacted. If you have any questions please give us a call at (888)364-8802 or send us an email at customerservice@brightlots.com



instructions. scroll further down to build your led pole kit

[Step 1 Select your LED Fixture Options](#)

FERIS LED Fixtures - 140 Lumens per Watt



- Select from 200 Watt or 300 Watt options
- Select your mounting bracket. In this case only Slip Fitter option is available as the poles are equipped with tenons to accommodate slip fitters.
- Select your photo sensor option.
- Select your motion sensor option.
- The quantity in this case will be 4

per kit. It is already set to 4 fixtures.

- Click on the "Review Your Selection" to move to pole options

Step 2 Select your Pole Options

20, 25, 30, 35 ft. LED-Ready Aluminum Tapered Poles



These poles come equipped with tenons that will accommodate 4 LED fixtures with slip fitters.

- Select from available pole heights: 20, 25, 30, 35 ft.
- Select the color option; dark bronze. Please note, dark bronze is the only color option for these kits if you are buying online. Other colors are available. Please give us a call at (888)364-8802 or send us an email at customerservice@brightlots.com
- Select the anchor bolt covers. There are two options; anchor covers or a complete pole base cover.
- Click on the "Review Your Selection" to do a final review of the kit you built.

Final Review and Purchase

Your Kit is Ready To Review

Take a look at the kit you built. It is a 4 fixture at 90 degrees pole kit. Please recheck your selections. Now you can order the quantity of kits you need for your project by inserting the quantity you need. Remember this is the kit quantity; if you order 2 kits it will mean you are ordering 8 LED fixtures and 2 poles.

1. LED Fixtures | FERIS

FERIS Series - 150-277V - 3000K x 4
 FERIS 120V Mounting Options Square P - SP
 FERIS 120V Photo Sensor - NS
 FERIS 120V Motion Sensor - MS (ASMR 537)
 \$940.00 **\$890.00**

EDIT

2. LED-Ready Aluminum Pole

LBR7AF-3201984840" 20 ft. 8" Butt Dia. 3.188 ga. 4 Fixture 90 LED
 90deg Light Pole
 Color: Dark Bronze
 Anchor Bolt Cover Options: 4 Anchor Covers
 \$1,433.07 **\$1,483.74**

EDIT

92-479-60 **\$2,384.74**

1 ADD TO CART

If you have any questions or are not sure of your selection or require a kit that is not available with these options give us a call at (888)364-8802 or email us at customerservice@brightlots.com

We offer other LED Pole kits that have single double triple heads and variety of combinations. Click Here to see our full line of LED Pole Kits.

[Read More](#)

SKU: N/A

Price: From: ~~\$3,168.02~~ **\$3,009.62**

Categories: [4 LED Aluminum Pole Kits](#), [LED Pole Kits](#)

3 LED ALUMINUM POLE KITS



BUILD YOUR LED-POLE KIT | 100W-300W LEDS | 10 FT. - 25 FT. SQUARE ALUMINUM POLE | 3 LED

Build your own LED-Pole Kit

Pole Selections: Square Aluminum Pole. Heights: 10ft., 15ft., 20ft., 25ft.
 LED Fixture Selections: FERIS Pole Top Fixtures. Wattages: 100W, 150W, 200W, 240W, 300W
 Voltage: 120-277V, 347-480V
 Finish Selections: Dark Bronze (standard), Black, White
 FREE Shipping
 Detailed Spec sheets are below under the DOWNLOAD tab

[Read More](#)

SKU: N/A

Price: From: ~~\$1,232.22~~ \$1,170.61

Categories: [3 LED Aluminum Pole Kits](#), [LED Pole Kits](#)

BUILD YOUR LED-POLE KIT | 100W-150W-200W LEDS | 20 FT. - 35 FT. ALUMINUM TAPERED POLE | 3 LEDS

Our LED - Pole Kits include 3 LED fixtures (100, 150, 200 Watts available) and one LED-Ready tapered aluminum poles (20, 25, 30, and 35 feet available). The kit also includes 3 head tenon top aluminum brackets at 180 degrees. The only available color for kit building is dark bronze. We can make these kits in black, gray, or white however these will be custom made and pricing and lead-time will be impacted. If you have any questions please give us a call at (888)364-8802 or send us



an email at customerservice@brightlots.com

instructions. scroll further down to build your led pole kit

[Step 1 Select your LED Fixture Options](#)

FERIS LED Fixtures - 140 Lumens per Watt

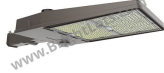

- Select from 100, 150 or 200 Watt
- Select your mounting bracket. In this case only Slip Fitter option is available as the poles are equipped with tenons to accommodate slip fitters.
- Select your photo sensor option.
- Select your motion sensor option.
- The quantity in this case will be 1 per kit. It is already set to 1 fixture.
- Click on the "Review Your Selection" to move to pole options

[Step 2 Select your Pole Options](#)

20, 25, 30 or 35 ft. LED-Ready Aluminum Tapered Poles



These poles come equipped with triple tenon inline bracket that will accommodate three LED fixtures with slip fitters at 180 degrees

- Select the color option; dark bronze. Please note, dark bronze is the only color option for these kits if you are buying online. Other colors are available. Please give us a call at (888)364-8802 or send us an email at customerservice@brightlots.com
- Select the anchor bolt covers. There are two options; anchor covers or a complete pole base cover.
- Click on the "Review Your Selection" to do a final review of the kit you built.

[Final Review and Purchase](#)

Your Kit is Ready To Review

Take a look at the kit you built. It is a 3 fixture at 180 degrees pole kit. Please recheck your selections. Now you can order the quantity of kits you need for your project by inserting the quantity you need. Remember this is the kit quantity; if you order 2 kits it will mean you are ordering 6 LED fixtures and 2 poles.

If you have any questions or are not sure of your selection or require a kit that is not available with these options give us a call at (888)364-8802 or email us at

1. LED Fixtures | FERIS



FERIS Series - 120-27V - 100W
 FERIS 120V, Mounting Option: Slip Fitter - SF
 FERIS 120V, Photo Sensor: Yes (Add \$15)
 FERIS 120V, Motion Sensor: Yes (Add \$37)
 \$187.00 **\$187.15**

EDIT

2. LED-Ready Aluminum Pole



LBRTAF-6201564B31** 20 ft, 6" Butt Dia, 0.156 ga, 3 Fixture 180, LED Ready Light Pole
 Color: Dark Bronze
 Anchor Bolt Cover Option: Complete Square Base Cover (Add \$128)
 \$1,225.00 **\$1,225.68**

EDIT

customerservice@brightlots.com

We offer other LED Pole kits that have single double triple heads and variety of combinations. Click Here to see our full line of LED Pole Kits.

[Read More](#)

SKU: N/A

Price: From: ~~\$2,002.45~~ \$1,902.33

Categories: [3 LED Aluminum Pole Kits](#), [LED Pole Kits](#)

2 LED ALUMINUM POLE KITS



BUILD YOUR LED-POLE KIT | 100W-300W LEDS | 10 FT. - 25 FT. SQUARE ALUMINUM POLE | 2 LED

Build your own LED-Pole Kit

Pole Selections: Square Aluminum Pole. Heights: 10ft., 15ft., 20ft., 25ft.

LED Fixture Selections: FERIS Pole Top Fixtures. Wattages: 100W, 150W, 200W, 240W, 300W

Voltage: 120-277V, 347-480V

Finish Selections: Dark Bronze (standard), Black, White

FREE Shipping

Detailed Spec sheets are below under the DOWNLOAD tab

[Read More](#)

SKU: N/A

Price: From: ~~\$1,077.12~~ \$1,023.26

Categories: [2 LED Aluminum Pole Kits](#), [LED Pole Kits](#)

BUILD YOUR LED-POLE KIT | 100W-150W-200W LEDS | 20 FT. - 25 FT. ALUMINUM TAPERED POLE | 2 LEDS

This LED - Pole Kit includes two LED fixtures of your choice (100, 150, 200 Watts available) and one of our 20 ft. or 25 ft. LED-Ready tapered aluminum poles. The kit also includes a two tenon top aluminum bracket. The only available color for the kit building is dark bronze. We can make these kits in black, gray, or white however these will be custom made and pricing and lead-time will be impacted. If you have any questions please give us a call at (888)364-8802 or send us an email at customerservice@brightlots.com



instructions. scroll further down to build your led pole kit

[Step 1 Select your LED Fixture Options](#)

FERIS LED Fixtures - 140 Lumens per Watt

- Select from 100, 150 or 200 Watt
- Select your mounting bracket. In this case only Slip Fitter option is available as the poles are equipped with tenons to accommodate slip fitters.
- Select your photo sensor option.
- Select your motion sensor option.
- The quantity in this case will be 1 per kit. It is already set to 1 fixture.
- Click on the "Review Your Selection" to move to pole options

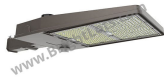

[Step 2 Select your Pole Options](#)

20 ft. or 25 ft. LED-Ready Aluminum Tapered Poles

These poles come equipped with double tenon inline bracket that will accommodate two LED fixtures with slip fitters at 180 degrees



- Select the color option; dark bronze. Please note, dark bronze is the only color option for these kits if you are buying online. Other colors are available. Please give us a call at (888)364-8802 or send us an email at customerservice@brightlots.com
- Select the anchor bolt covers. There are two options; anchor covers or a

complete pole base cover.

- Click on the "Review Your Selection" to do a final review of the kit you built.

[Final Review and Purchase](#)

Your Kit is Ready To Review

Take a look at the kit you built. It is a 2 fixture at 180 degrees pole kit. Please recheck your selections. Now you can order the quantity of kits you need for your project by inserting the quantity you need. Remember this is the kit quantity; if you order 2 kits it will mean you are ordering 4 LED fixtures and 2 poles.

If you have any questions or are not sure of your selection or require a kit that is not available with these options give us a call at (888)364-8802 or email us at customerservice@brightlots.com

We offer other LED Pole kits that have single double triple heads and variety of combinations. Click Here to see our full line of LED Pole Kits.

[Read More](#)

SKU: N/A

Price: From: ~~\$2,132.83~~ \$2,026.19

Categories: [2 LED Aluminum Pole Kits](#), [LED Pole Kits](#)

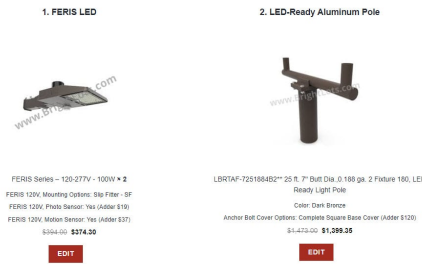

1 LED ALUMINUM POLE KIT



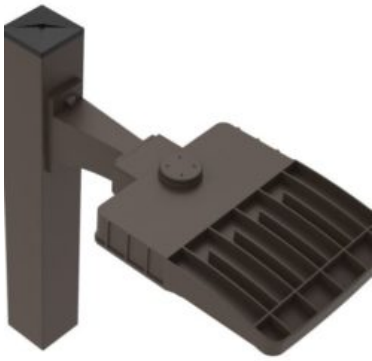

BUILD YOUR LED-POLE KIT | 100W-300W LEDS | 10 FT. - 25 FT. SQUARE ALUMINUM POLE | 1 LED

Build your own LED-Pole Kit

Pole Selections: Square Aluminum Pole. Heights: 10ft., 15ft., 20ft., 25ft.
LED Fixture Selections: FERIS Pole Top Fixtures. Wattages: 100W, 150W, 200W, 240W, 300W

Voltage: 120-277V, 347-480V

Finish Selections: Dark Bronze (standard), Black, White

FREE Shipping

Detailed Spec sheets are below under the DOWNLOAD tab

[Read More](#)

SKU: N/A

Price: From: ~~\$922.02~~ \$875.92

Categories: [1 LED Aluminum Pole Kit](#), [LED Pole Kits](#)

BUILD YOUR LED-POLE KIT | 100W-150W-200W LEDS | 20 FT. ALUMINUM TAPERED POLE | 1 LED

This LED - Pole Kit includes a single LED fixtures (100, 150, 200 Watts available) and one 20 ft. LED-Ready tapered aluminum poles. The kit also includes single tenon top aluminum bracket. The only available color for kit building is dark bronze. We can make these kits in black, gray or white however these will be custom made and pricing and lead-time will be impacted. If you have any questions please give us a call at (888)364-8802 or send us an email at customerservice@brightlots.com



instructions. scroll further down to build your led pole kit

[Step 1 Select your LED Fixture Options](#)

FERIS LED Fixtures - 140 Lumens per Watt



- Select from 75, 100 or 150 Watt
- Select your mounting bracket. In this case only Slip Fitter option is available as the poles are equipped with tenons to accommodate slip fitters.
- Select your photo sensor option.
- Select your motion sensor option.
- The quantity in this case will be 1 per kit. It is already set to 1 fixture.
- Click on the "Review Your Selection"

to move to pole options

[Step 2 Select your Pole Options](#)

20, ft. LED-Ready Aluminum Tapered Poles

These poles come equipped with single tenon that will accommodate a single LED fixtures with slip fitters.



- Select the color option; dark bronze. Please note, dark bronze is the only color option for these kits if you are buying online. Other colors are available. Please give us a call at (888)364-8802 or send us an email at customerservice@brightlots.com
- Select the anchor bolt covers. There are two options; anchor covers or a complete pole base cover.
- Click on the "Review Your Selection" to do a final review of the kit you built.

[Final Review and Purchase](#)

Your Kit is Ready To Review

Take a look at the kit you built. It is a 4 fixture at 90 degrees pole kit. Please recheck your selections. Now you can order the quantity of kits you need for your project by inserting the quantity you need. Remember this is the kit quantity; if you order 2 kits it will mean you are ordering 8 LED fixtures and 2 poles.

1. FERIS LED



FERIS Series - 120-277V - 200W
 FERIS 120V Mounting Options: Slip Fitter - SF
 FERIS 120V Photo Sensor: No
 FERIS 120V Motion Sensor: No
 \$198.00 **\$198.10**
[EDIT](#)

2. Single LED Pole



LBR1AF-6201054511 20 ft. 6" Ball Dia. 2.155 ga. 1 Fixture, LED Ready Light Pole.
 Color: Dark Bronze
 Anchor Bolt Cover Options: 4 Anchor Covers
 \$349.00 **\$350.00**
[VIEW](#)

\$1,149.00 **\$1,088.70**

1 [ADD TO CART](#)

If you have any questions or are not sure of your selection or require a kit that is not available with these options give us a call at (888)364-8802 or email us at customerservice@brightlots.com

We offer other LED Pole kits that have single double triple heads and variety of combinations. Click Here to see our full line of LED Pole Kits.

[Read More](#)

SKU: N/A

Price: From: ~~\$1,570.20~~ **\$1,491.70**

Categories: [1 LED Aluminum Pole Kit](#), [LED Pole Kits](#)

INDEX

B

Build Your LED-Pole Kit | 100W-150W-200W LEDs | 20 ft. - 35 ft. Aluminum Tapered Pole | 3 LEDs 4, 14

Build Your LED-Pole Kit | 100W-150W-200W LEDs | 20 ft. Aluminum Tapered Pole | 1 LED 9, 19

Build Your LED-Pole Kit | 100W-150W-200W LEDs | 20 ft. - 25 ft. Aluminum Tapered Pole | 2 LEDs 6, 17

Build Your LED-Pole Kit | 100W-300W LEDs | 10 ft. - 25 ft. Square Aluminum Pole | 1 LED 4, 19

Build Your LED-Pole Kit | 100W-300W LEDs | 10 ft. - 25 ft. Square Aluminum Pole | 2 LED 3, 16

Build Your LED-Pole Kit | 100W-300W LEDs | 10 ft. - 25 ft. Square Aluminum Pole | 3 LED 3, 14

Build Your LED-Pole Kit | 100W-300W LEDs | 10 ft. - 25 ft. Square Aluminum Pole | 4 LED 2, 12

Build Your LED-Pole Kit | 200W-300W LEDs | 20 ft. - 35 ft. Aluminum Tapered Pole | 4 LEDs 7, 12

W

WYSE-Series Decorative LED Pole Kit | 60W, 100W | 12ft., 14ft., 16ft. | Anchor Base 2, 11